

**MAIN FEATURES**

Absolute linear system based on magnetic principle without wear thanks to no-contact technology. Thanks to high IP rating TMAA is suitable for harsh environment applications such as marble and glass working machines or washing systems machines.

- 5 µm max absolute resolution / 1 µm incremental resolution
- Power supply up to +30 V DC with SSI electrical interface
- Up to 5 m/s travel speed
- IP 67 as protection grade
- M12 radial connector
- To be used with BMAA magnetic tape



ORDERING CODE	TMAA	5	G	5/30	S	1	L	G	S	M12R	.162
<b>SERIES</b> magnetic absolute linear sensor <b>TMAA</b>											
<b>ABSOLUTE RESOLUTION</b> 5 µm <b>5</b> 10 µm <b>10</b>											
<b>CODE TYPE</b> gray <b>G</b>											
<b>POWER SUPPLY</b> 5 ... 30V DC <b>5/30</b>											
<b>ELECTRICAL ABSOLUTE INTERFACE</b> Serial Synchronous Interface - SSI <b>S</b>											
<b>INCREMENTAL RESOLUTION</b> without incremental signals <b>X</b> 1 µm <b>1</b> 5 µm <b>5</b> 10 µm <b>10</b>											
<b>ELECTRICAL INCREMENTAL INTERFACE</b> to be reported if not used <b>X</b> RS-422 <b>L</b>											
<b>MAX INCREMENTAL SIGNALS FREQUENCY</b> to be reported if not used <b>X</b> 1250 kHz <b>A</b> 100 kHz <b>D</b> 15 kHz <b>G</b> refer to the table for travel speed limits											
<b>ENCLOSURE RATING</b> IP 67 <b>S</b>											
<b>OUTPUT TYPE</b> 12 pin M12 radial connector <b>M12R</b>											
<b>VARIANT</b> without mating connector <b>.162</b>											

TMAA

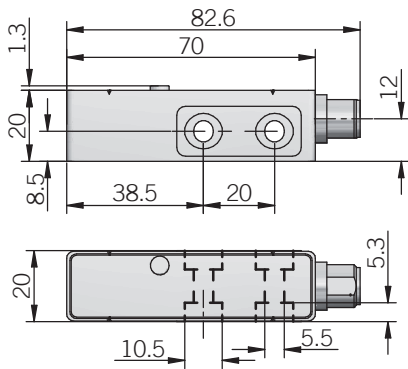

Mounting tolerances

Longitudinal tilt

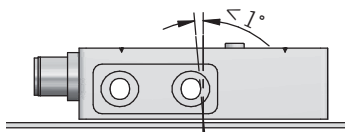

Lateral tilt

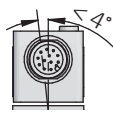

Alignment error

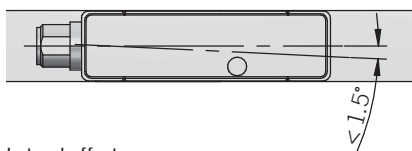

Lateral offset

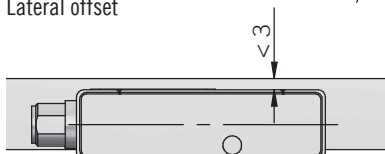

Working distance (airgap)

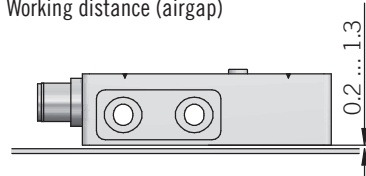

dimensions in mm

for connector please refer to Accessories

INCREMENTAL FREQUENCY - TRAVEL SPEED

Resolution (µm)	Travel speed (m/s)		
	4	0,32	0,05
1	20	1,60	0,25
5	25	3,20	0,50
Max frequency (Khz)	1250	100	15,63

SSI INTERFACE

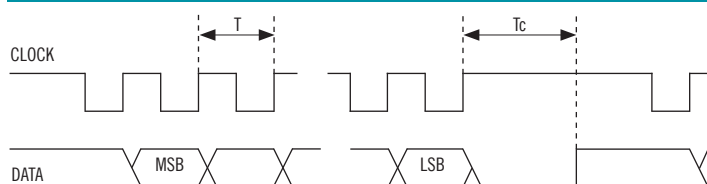

CLOCK Input from controller  
 T Clock signal period  
 Tc Pause time

ELECTRICAL SPECIFICATIONS

Absolute resolution	5 - 10 µm
Incremental resolution	1 - 5 µm
Stroke	≤ 10240 mm
Power supply <sup>1</sup>	4,5 ... 30 V DC (reverse polarity protection)
Power draw without load	< 1,5 W
Electrical interface for absolute signals <sup>2</sup>	RS-422
Electrical interface for incremental signals <sup>2</sup>	RS-422
Clock frequency	50 ... 750 kHz
Pause time (Tc)	> 25 µs
SSI frame	(MSB ... LSB) 27 bit data length 24 bit data + 3 bit status
Code type	gray
Accuracy (sensor+tape)	± (0,02 + 0,03 x lenght) mm lenght in meter
Repeatability	± 5 µm, ± 1 increment
Max travel speed	≤ 5 m/s for absolute output refer to the table for incremental output
Electromagnetic compatibility	according to 2014/30/EU directive
RoHS	according to 2015/863/EU directive

MECHANICAL SPECIFICATIONS

Enclosure rating	IP 67 (IEC 60529)
Shock	50 G, 11 ms (IEC 60068-2-27)
Vibration	20 G, 10 ... 2000 Hz (IEC 60068-2-6)
Housing material	zinc die-cast
Operating temperature <sup>3, 4</sup>	-30° ... +85°C (-22° ... +185°F)
Storage temperature <sup>4</sup>	-40° ... +85°C (-40° ... +185°F)
Working distance from magnetic tape without steel cover tape	0,2 ... 1,3 mm
Weight	80 g (2,82 oz)

<sup>1</sup> as measured at the transducer without cable influences

<sup>2</sup> for further details refer to OUTPUT LEVELS on TECHNICAL BASICS section

<sup>3</sup> measured on transducer housing

<sup>4</sup> condensation allowed

CONNECTIONS

Function	M12 connector 12 pin
+ V DC	5
0 V	12
A+	7
A-	6
B+	9
B-	8
DATA +	2
DATA -	3
CLOCK +	11
CLOCK -	4
PROG	10



M12 connector (12 pin)  
 M12 A coded  
 solder side view FV